

Product Special

ARS-System Atraumatic Retraction System

Produktinformationen Product information

ARS – Das Atraumatische Retraktionssystem für Sternotomien

- Universell einsetzbar
- Verwendbar mit verschiedenen Atriumhaken und weiterem Zubehör (z.B. Leyla-Arm)
- Halterung für Nahtmaterial zur Fixierung und Organisation der Fäden (bis zu 10 St.) während Operationen mit und ohne Herz-Lungen-Maschine
- Design des Systems erlaubt größtmögliche Exposition des OP-Feldes
- OP-Tischanbindung

ARS - The Atraumatic Retraction System for sternotomies

- Universal and modular system
- To be used with various atrial retractor blades and additional accessories (e.g. snake arm)
- Integrated suture holders for fixation and organization of sutures (up to 10 sutures) during operations with and without heart-lung machine
- Design of the system allows maximum possible exposition of OR field
- OR-table fixation arm

rudolfstorz®

Weiteres Zubehör s. Rückseite
Additional accessories (see back)

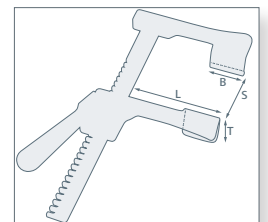
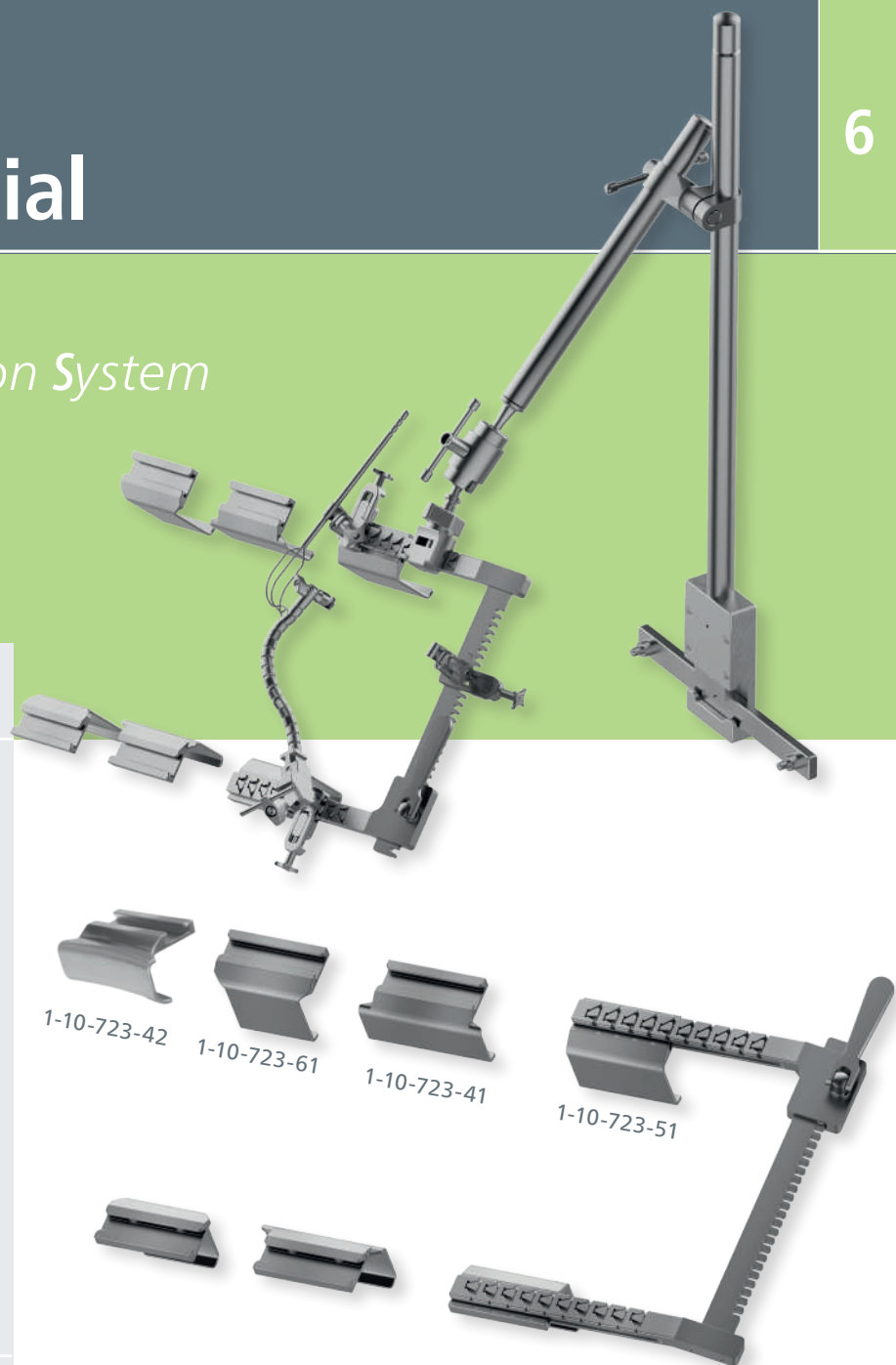



ARS-SPERRER mit 4 Valvenpaaren
ARS-Spreader with 4 pairs of blades

	Beschreibung Description	Spreizweite Spreading width (S)	Armlänge Arm length (L)
2-10-600-05	ARS-Sperrer mit Fadenklemmen ARS-Spreader with suture holders	245mm	193mm
inklusive inclusive		Breite width (B)	Tiefe depth (T)
1-10-723-51	Valvenpaar / pair of blades	80mm	50mm
1-10-723-41	Valvenpaar / pair of blades	100mm	40mm
1-10-723-61	Valvenpaar / pair of blades	60mm	60mm
1-10-723-42	Valvenpaar gewölbt / pair of blades curved	100mm	30mm

Product Special

COOLEY DRAHTVALVEN, Schaftdurchmesser: 6mm
Cooley atrial blades, shaft diameter: 6mm

Artikelnummer <i>Item number</i>	Breite <i>width</i>	Tiefe <i>length</i>	Biegsam <i>malleable</i>
1-10-709-05	28 mm	35 mm	
1-10-709-10	38 mm	48 mm	
1-10-709-15	38 mm	35 mm	
1-10-709-20	42 mm	22 mm	
1-10-709-25	28 mm	35 mm	
1-10-709-30	38 mm	48 mm	
1-10-709-35	38 mm	35 mm	
1-10-709-40	42 mm	22 mm	

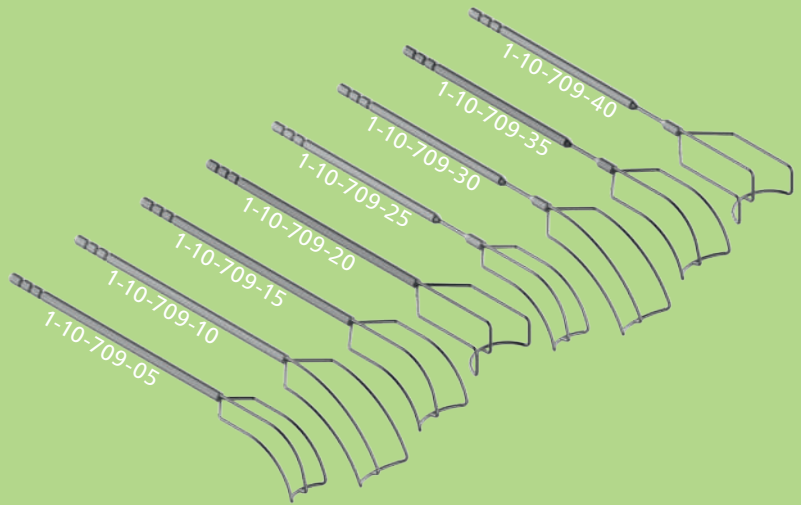

2-10-600-20

Klemme zur Fixierung von Valven/
Retraktoren (z.B. Cooley-Valven),
Durchmesser 6mm
*Clamp for fixation of blades/
retractors (e.g. Cooley blades),
diameter 6mm*

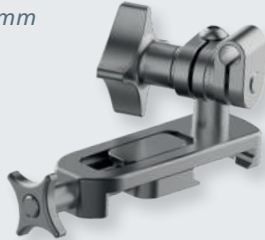

2-10-600-22

Klemme für Leyla-Arm zur
Verwendung mit ARS-Sperrer
*Clamp for Leyla arm for use with
ARS-spreader*



Änderungen der technischen Angaben und Maße liegen in unserem Ermessen. Modelländerungen vorbehalten. Ohne unsere ausdrückliche schriftliche Genehmigung darf dieses Printmedium weder im Gesamten noch auszugsweise kopiert oder nachgedruckt werden.

Changes in technical specifications and dimensions are at our discretion. Subject to modification. Without our explicit written approval this print media may not be copied or reprinted as a whole or in extracts.

2-10-600-25

Flexibler Arm (Typ Leyla), Länge 185mm
Flexible arm (type Leyla), length 185mm



2-10-600-30

Haltearm zur Adaption des ARS-
Sperrers an OP-Tisch
*Fixation arm for adaption of
ARS-spreader to OR-table*

